

Four® Eating

Design: Strand + Hvas

Table top finishes



Frame colours



Options

Chair suspension

Cable duct, aluminium

Linking device

Four® Eating

EN

Design: Strand + Hvas

1200 x 800

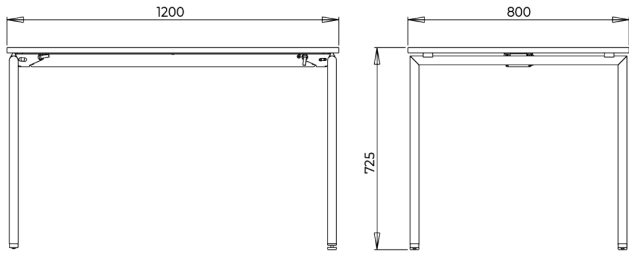

1400 x 800

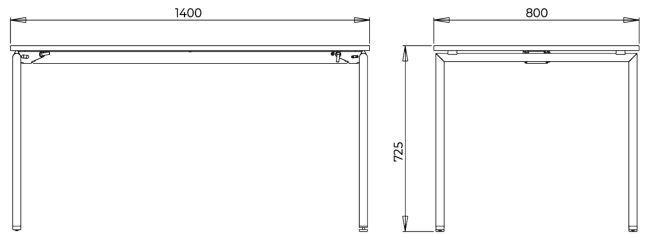

1600 x 800

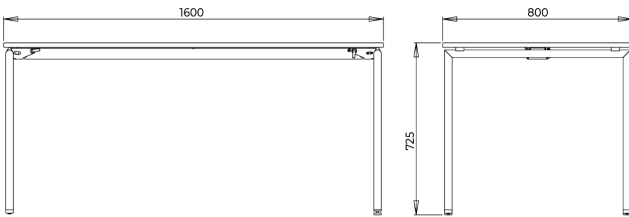

1800 x 800

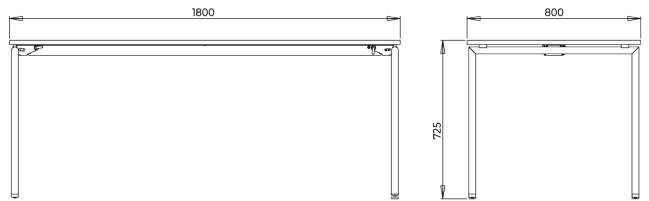

800 x 800

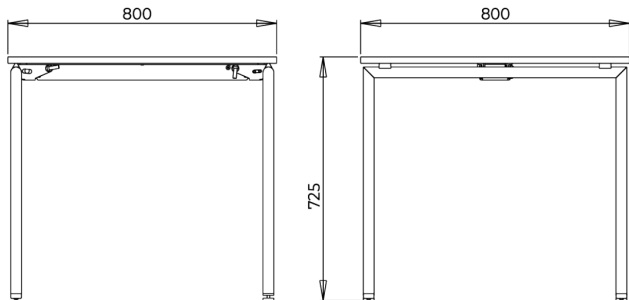

Ø1200 Fixed Legs

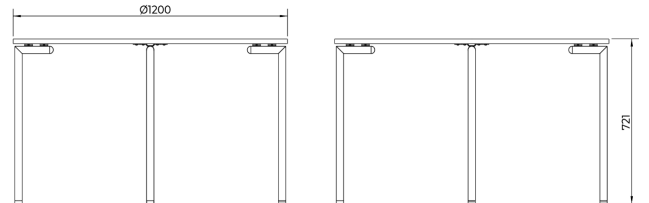

FOUR
DESIGN



AN OCEE
INTERNATIONAL
COMPANY

Four® Eating

EN

Design: Strand + Hvass

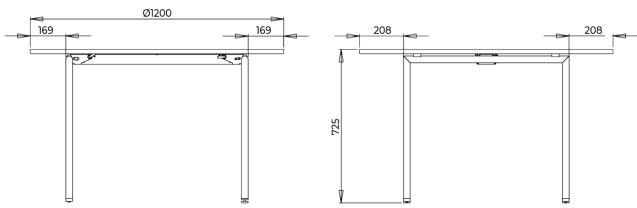
Ø1200



FOUR
DESIGN

AN OCEE
INTERNATIONAL
COMPANY

Design: Strand + Hvass

Materials

Table top variants

Chip board with Decor laminate and ABS-edge.
Thickness: 19 mm.

Chip board with high-pressure laminate or Fenix laminate and ABS edge.
Thickness 21 mm.

Chip board with linoleum and ABS-edge.
Thickness 23 mm.

Frame

Legs: Ø32x2 mm, steel, form 300 C - EN 10305-3.
Beam: Aluminium EN AW-5754.
Folding mechanism: Domex 355-FE 360 D2, steel
2 integrated castors: Pa6
2 gliders: Pa6
Rubber buffer: EPDM rubber

Fasteners

Screw: 6,2x 16 mm
Screw: M6x16, countersunk head, hexagon socket
Screw: M6x16, button head, hexagon socket
Screw: M10x30, button head, hexagon socket
Hexagon nut: M10 with clamping
Spring washer: 10x20

Instructions

Assembly instructions can be found at www.fourdesign.dk under Four Eating.

Weight and dimensions

80x80 cm: 16,6 kg
120x80 cm: 23,7 kg
140x80 cm: 25,6 kg
160x80 cm: 29,5 kg
180x80 cm: 32 kg
Ø120 cm (foldable): 24,3 kg
Ø120 cm (non-foldable): 23,5 kg

Quality and Environment

At Four Design, we are aware of our environmental responsibility. We strive to reduce our company, and our customer's impact on the environment by producing quality furniture in a sustainable manner.

Procurement

We procure materials from responsible suppliers who comply with our high standards, ensuring that the materials are sustainably sourced and managed, conforming to applicable laws and regulations such as legal logging and chemical restrictions.

Production

We are ISO14001 certified, guaranteeing excellent environmental standards of our manufacturing sites.

Use

Four Design provides a 5-year warranty on all products within our price list. This warranty covers breakage and damage of products occurring because of deficient craftsmanship performance under normal use. The warranty shall lapse if the product shows signs of mishandling abuse or other physical damage. The warranty does not cover those parts of the product which are exposed to abrasion during use.

We kindly refer to our Maintenance Guide: http://www.fourdesign.dk/pdf/Maintenance_Guide.pdf

Recycling

We are working towards the aim for all our products to be minimum 95% recyclable. Products must be separated into their components and disposed of separately. All metal parts can be disposed of and recycled by an approved organisation. Lacquered frames are treated with a paint classified as not dangerous according to directive 1999/45/EF. Wood can either be recycled or incinerated. Plastic shells can be recycled. The shell will be granulated and reused in new plastic production. Upholstery and veneer shells are not recyclable but can be disposed of by incineration.